

## Body worn 410-430MHz Tetra Antenna

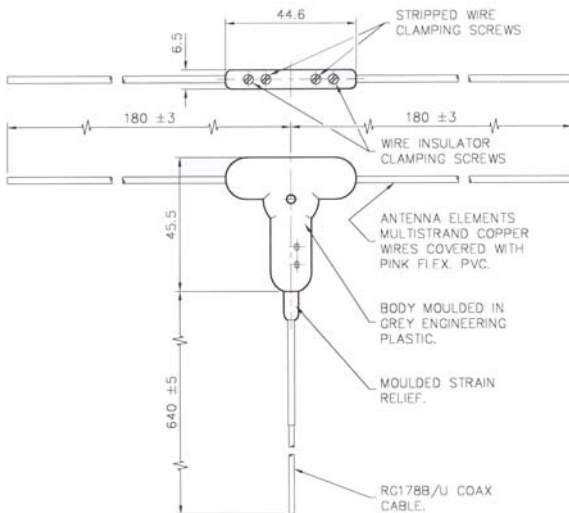
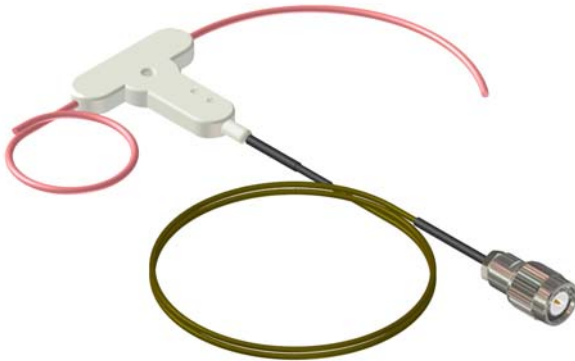

### Electrical Data

<b>Frequency Range (MHz)</b>	410 - 430
<b>Gain: Isotropic</b>	2dBi
<b>Compared with ¼ wave</b>	0dB
<b>Polarisation</b>	Vertical
<b>Configuration</b>	Flexible ½ Wave Dipole Element

### Mechanical Data

<b>Dimensions (mm)</b>	<b>Length</b>	45.5
	<b>Width</b>	44.6
	<b>Thickness</b>	6.5
<b>Weight (g)</b>		
<b>Operating Temp (°C)</b>		-40° / +80°C
<b>Material</b>		Grey Engineering Plastic
<b>Colour</b>		Grey

### Antenna Element Data

<b>Antenna Element Length (mm)</b>	180 × 2
<b>Type</b>	Multistrand Copper Wires
<b>Colour</b>	Pink

### Cable Data

<b>Length (mm)</b>	640
<b>Type</b>	RG178B/U Coax Cable

VSWR v Freq (MHz)

